

1. Package Contents

Thank you for purchasing PLANET 8-Port 10/100/1000T Wall-mounted Gigabit Ethernet Switch, WGS-803.

Open the box of the WGS-803 Gigabit Ethernet Switch and carefully unpack it. The box should contain the following items:

- The WGS-803 Gigabit Ethernet Switch x 1
- User Manual x 1
- DIN-rail Kit x 1
- Wall-mounted Kit x 1
- Magnet Kit x 1
- 3-pin Terminal Block Connector x 1
- RJ45 Dust-proof Cap x 8

If any item is found missing or damaged, please contact your local reseller for replacement.

- 1 -

2.1 Terminal Block Connector Pinouts

To install the 3-pin Terminal Block Connector on the WGS-803, simply follow the following steps:

Step 1: Insert positive DC power wire into **V+**, negative DC power wire into **V-**, and grounding wire into **Ground**.

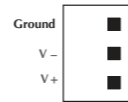

Step 2: Tighten the wire-clamp screws for preventing the wires from loosening and plug into the wall-mounted switch.

- Note**
1. The wire gauge should be in the range from 12 to 24 AWG
 2. The device must be grounded
 3. The DC power input range is 12V ~ 48V DC

2.2 LED Indicators

■ System

LED	Color	Function
PWR	Green	Lights to indicate that the Switch has power.

- 3 -

2.3 Product Specifications

Model	WGS-803
Hardware Specifications	
Network Connector	8-port RJ45 for 10/100/1000BASE-T
MAC Address Table	8K MAC address table with auto learning function
Data Buffer	64Kbytes
Switch Fabric	16Gbps
Switch Throughput	11.9Mpps@64bytes
Flow Control	Back pressure for half duplex. IEEE 802.3x pause frame for full duplex
Power Requirements	12~48V DC, 0.5A (max.)
Power Consumption	6 watts/20BTU
ESD Protection	6KV DC
EFT Protection	6KV DC
Enclosure	IP30 aluminum

- 5 -

2.4 Physical Dimensions (WxDxH): 148 x 24.2 x 134mm

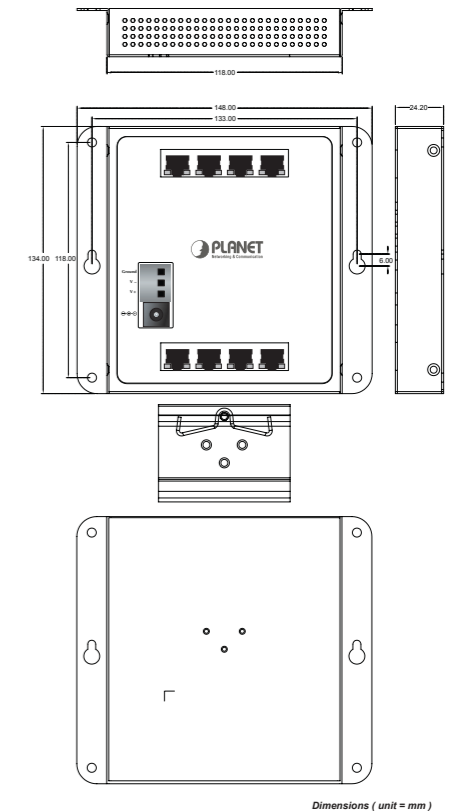

- 7 -

2. Hardware Description

The front panel of the WGS-803 Gigabit Ethernet Switch consists of 8 Auto-sensing 10/100/1000Mbps Ethernet RJ45 Ports. The LED Indicators are also located on the RJ45 ports of the Gigabit Ethernet Switch.

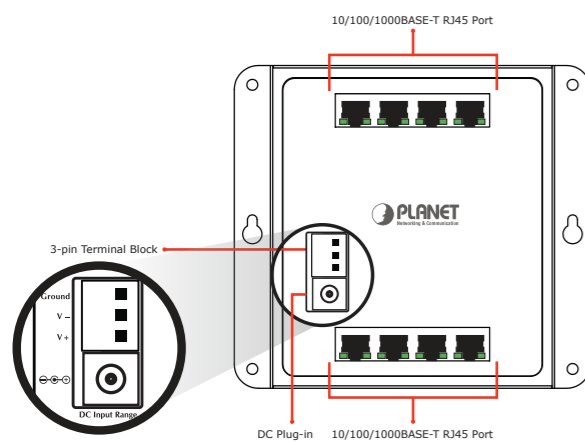

- 2 -

■ 10/100/1000BASE-T Interfaces

LED	Color	Function
LNK/ACT	Green	Lights To indicate the link through that port is successfully established. Blinks To indicate that the switch is actively sending or receiving data over that port.
1000	Green	Lights To indicate that the port is operating at 1000Mbps . Off If LNK/ACT LED is lit, it indicates that the port is operating at 10/100Mbps . If LNK/ACT LED is Off, it indicates that the port is link-down.

- 4 -

Dimensions (W x D x H)	148 x 24.2 x 134 mm
Weight	498g
Standard Conformance	
Standard Compliance	IEEE 802.3 Ethernet IEEE 802.3u Fast Ethernet IEEE 802.3ab Gigabit Ethernet IEEE 802.3x Flow Control
Regulatory Compliance	FCC Part 15 Class A, CE
Environment	
Operating	Temperature: -10 ~ 60 degrees C Relative Humidity: 5 ~ 95% (non-condensing)
Storage	Temperature: -20 ~ 70 degrees C Relative Humidity: 5 ~ 95% (non-condensing)

- 6 -

3. Installation

3.1 Wall Mount Installation

To install the WGS-803 Gigabit Ethernet Switch on the wall, simply follow the following steps:

- Step 1:** There are 4 holes with 8mm diameter on the wall; the distance between the 2 holes is 133mm and the line through them must be horizontal.
- Step 2:** Install a conductor pipe inside the board hole and flush the edge of the conductor pipe with the wall surface.
- Step 3:** Screw the bolts into the conductor pipe. The WGS-803 is between bolts and conductor pipe, as shown below.

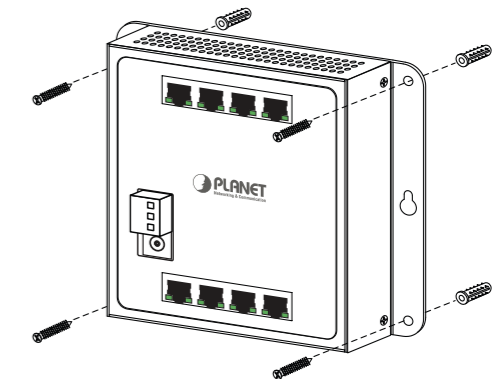

- 8 -

3.2 DIN-rail Mounting Installation

The DIN-rail kit is included in the WGS-803 package. When the wall-mount application for the WGS-803 needs to be replaced with DIN-rail application, please refer to the following figures to screw the DIN-rail on the WGS-803. To hang up the WGS-803, follow the steps below:

Step 1: Screw the DIN-rail on the WGS-803

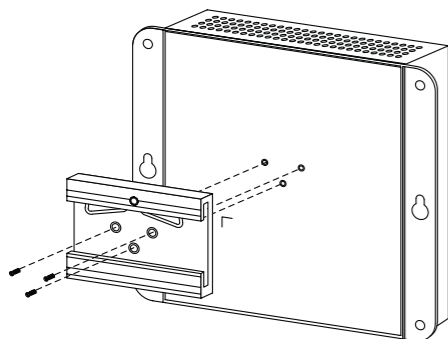

- 9 -

3.3 Magnet Installation

To install the WGS-803 on a magnetic surface, simply follow the following diagram:

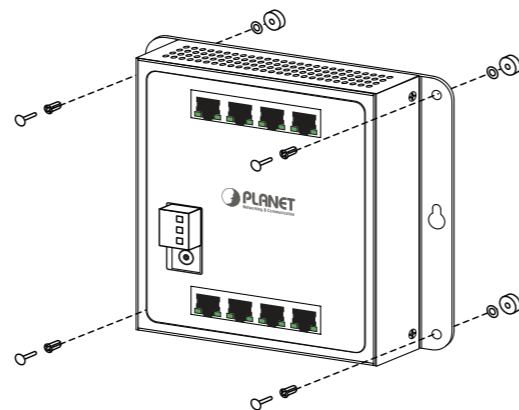

- 11 -

Step 2: Lightly insert the bottom of DIN-rail into the track

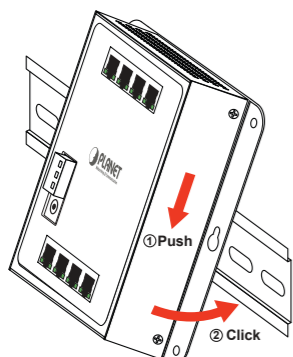

Step 3: Check whether the DIN-rail is tightly on the track

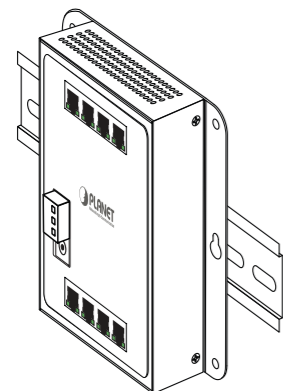

- 10 -

4. Customer Support

Thank you for purchasing PLANET products. You can browse our online FAQ resource and User's Manual on PLANET Web site first to check if it could solve your issue. If you need more support information, please contact PLANET switch support team.

PLANET online FAQ:
<http://www.planet.com.tw/en/support/faq.php?type=1>

Switch support team mail address:
support_switch@planet.com.tw

Copyright © PLANET Technology Corp. 2015.
 Contents are subject to revision without prior notice.
 PLANET is a registered trademark of PLANET Technology Corp. All other trademarks belong to their respective owners.

- 12 -

Unmanaged Switch WGS-803

www.PLANET.com.tw

8-Port 10/100/1000T Wall-mounted Gigabit Ethernet Switch



PLANET Technology Corp.
2350-A36030-001



EC Declaration of Conformity

For the following equipment:

*Type of Product: Industrial 8-Port 10/100/1000T Wall-mount Switch
 *Model Number: WGS-803

* Produced by:
 Manufacturer's Name : Planet Technology Corp.
 Manufacturer's Address: 10F., No.96, Minquan Rd., Xindian Dist., New Taipei City 231, Taiwan (R.O.C.)

is herewith confirmed to comply with the requirements set out in the Council Directive on the Approximation of the Laws of the Member States relating to Electromagnetic Compatibility Directive on (2004/108/EC).

For the evaluation regarding the EMC, the following standards were applied:

EN 55022	(2010)
EN 61000-3-2	(2006 + A2:2009)
EN 61000-3-3	(2008)
EN 55024	(2010)
EN 61000-4-2	(2009)
EN 61000-4-3	(2006 + A2:2010)
EN 61000-4-4	(2012)
EN 61000-4-5	(2006)
EN 61000-4-6	(2009)
EN 61000-4-8	(2010)
EN 61000-4-11	(2004)

Responsible for marking this declaration if the:

Manufacturer Authorized representative established within the EU

Authorized representative established within the EU (if applicable):

Company Name: Planet Technology Corp.

Company Address: 10F., No.96, Minquan Rd., Xindian Dist., New Taipei City 231, Taiwan (R.O.C.)

Person responsible for making this declaration

Name, Surname: Kent Kang

Position / Title: Product Manager

Taiwan
Place

28th April, 2015
Date

Kent Kang
Legal Signature

PLANET TECHNOLOGY CORPORATION

e-mail: sales@planet.com.tw <http://www.planet.com.tw>
 10F., No.96, Minquan Rd., Xindian Dist., New Taipei City, Taiwan, R.O.C. Tel:886-2-2219-9518 Fax:886-2-2219-9528